

A3C Series 3.2 x 2.5 mm SMD Automotive Crystal Oscillator

A : Automotive

3 : 3.2×2.5×0.95 mm | SMD3225-4P

C : Crystal Oscillator

Feature

- Ceramic surface mount with Metal Lid
- CMOS compatible logic levels
- Tri-state function available
- Supply voltage range : 1.62V ~ 3.63V(Compatible with 1.8V, 2.5V, 3.3V)
- AEC-Q200 Qualified
- RoHS Compliant / Pb Free

Applications

- Automotive navigation system
- Automotive audio equipment
- Image processing for self-driving
- Automotive Car audio and video entertainment system

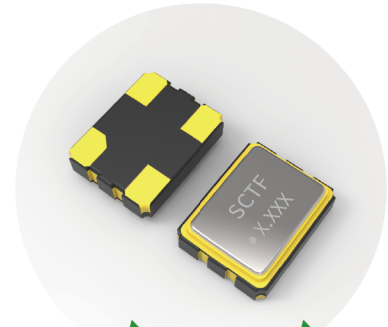

Electrical Specifications

Item	Symb.	Min.	Typ.	Max.	Unit	Notes
Frequency Range	Freq.	1.000		54.000	MHz	
Operating Temperature	T_use	-40		85	°C	
		-40		105	°C	
		-40		125	°C	
Storage Temperature Range	T_stg	-55		125	°C	
Supply Voltage	Vdd	1.62	1.8/2.5/3.3	3.63	V	
Output Load	L_CMOS		15		pF	
Current Consumption	Icc			10	mA	1MHz ≤ Freq. < 40MHz
				20		40MHz ≤ Freq. ≤ 54MHz
Duty Cycle	SYM	45		55	%	50 % Vdd level, L_CMOS ≤ 15 pF
Rise / Fall Time	T _R / T _F			5	nS	10% Vdd to 90% Level
Start-up Time	T_str			5	mS	To 90% of Final Amplitude
High output voltage	V _{OH}	0.9Vdd			V	
Low output voltage	V _{OL}			0.1Vdd	V	
Enable Voltage High(Logic 1)	V _{IH}	0.7Vdd			V	Output will be disable if OE is Logic 0 Output will be enable if OE is Logic 1 or open
Enable Voltage Low(Logic 0)	V _{IL}			0.3Vdd	V	
Aging	f_age			3	ppm	1st. Year at 25°C

Frequency Stability & Operating Temperature Range

Temp.	FT	±25ppm	±30ppm	±50ppm	±100ppm
		-40°C to +85°C	△	★	★
-40°C to +105°C		△	★	★	
-40°C to +125°C			△	★	

★: Available △: Conditional

All condition: Include 25°C tolerance, operating temperature range, input voltage change, aging, load change.

A3C Series 3.2 x 2.5 mm SMD Automotive Crystal Oscillator

A : Automotive

3 : 3.2×2.5×0.95 mm | SMD3225-4P

C : Crystal Oscillator

Dimensions (UNIT:mm)

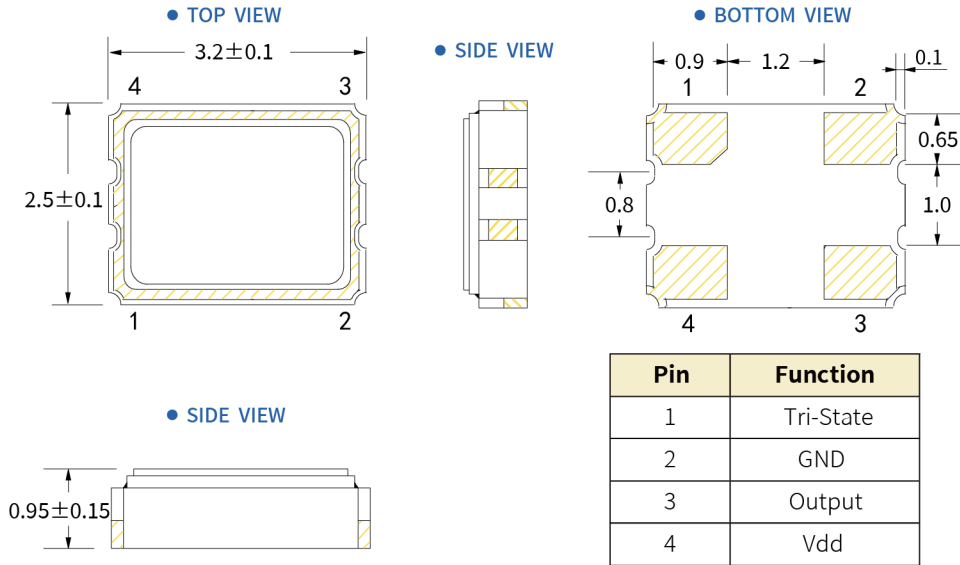

Solder pad layout (UNIT:mm)

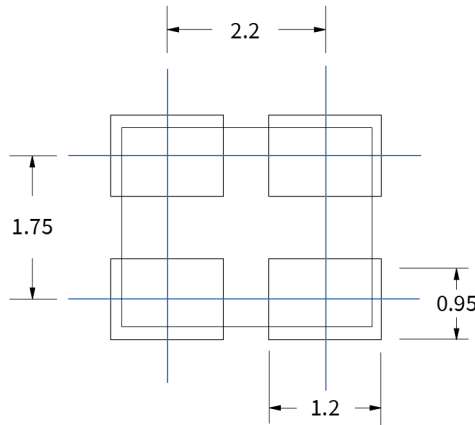

Options and Part Identification : Example SXA3M1.000B20F30TNN

Company	Ratings	Ceramic Package	Frequency Code [MHZ]	Supply Voltage	Frequency Tolerance	Operating Temperature	Frequency Drift	Output	Current Consumption	Phase Noise
SX	A	3M	X.XXX	B	20	F	30	T	N	N
Code Company	Code Ratings	Code Ceramic Package	Frequency	Code Voltage	Code Frequency Tolerance	Code Operating Temperature	Code Frequency Drift	Code Output	Code Current	Code Phase Noise
SX SCTF	Blank Standard A AEC-Q100,AEC-Q200	7M 7.0×5.0×1.3mm 5M 5.0×3.2×1.2mm 3M 3.2×2.5×0.95mm 2M 2.5×2.0×0.81mm 1M 2.0×1.6×0.75mm	1.000 13.560 19.200 37.125	D 1.8V H 2.5V B 3.3V A 5.0V	10 ±10ppm 20 ±20ppm	F -40°C ~ +85°C G -40°C ~ +105°C M -40°C ~ +125°C	15 ±15ppm 20 ±20ppm 30 ±30ppm 50 ±50ppm 100 ±100ppm	T Squarewave	N Standard	N Standard

If you have other parameter requirements, you can contact **SCTF** at any time.

A3C Series 3.2 x 2.5 mm SMD Automotive Crystal Oscillator

A : Automotive

3 : 3.2×2.5×0.95 mm | SMD3225-4P

C : Crystal Oscillator

Frequency Temperature Characteristics

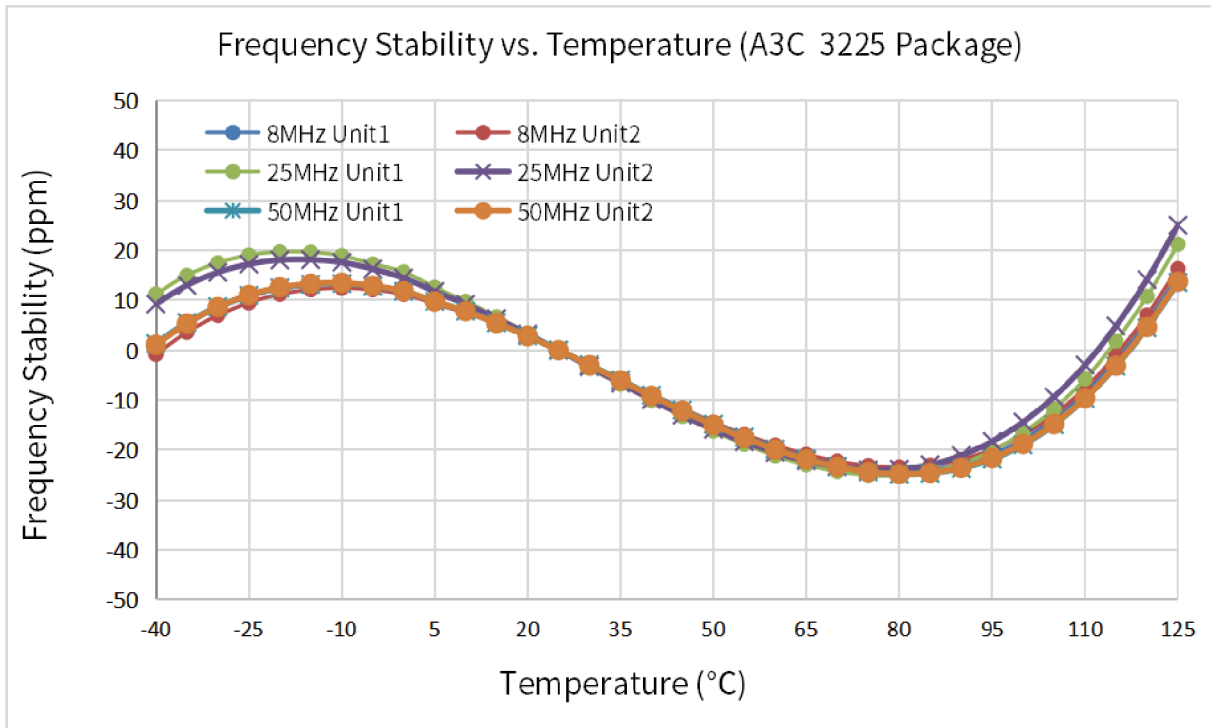

Product Structure & Marking Information

Product Structure

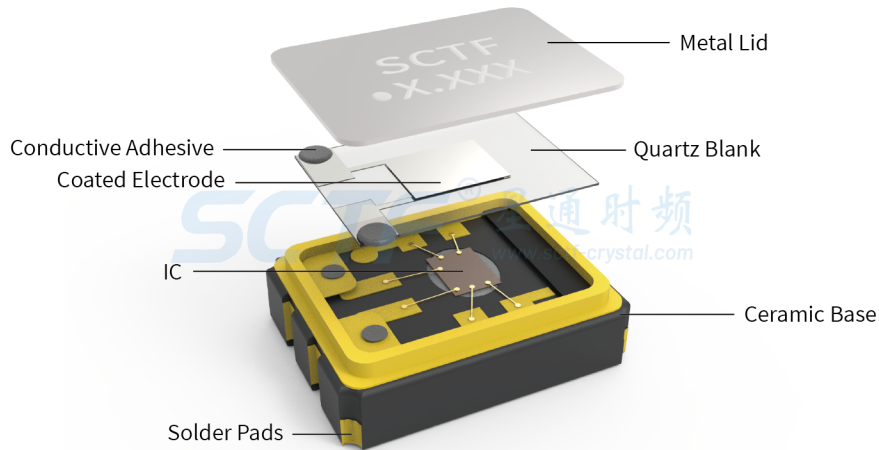

Marking Information

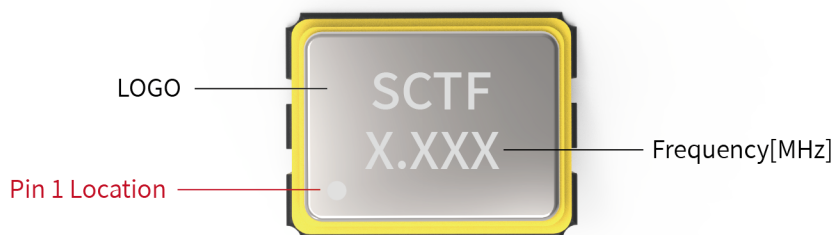

A3C Series 3.2 x 2.5 mm SMD Automotive Crystal Oscillator

A : Automotive

3 : 3.2×2.5×0.95 mm | SMD3225-4P

C : Crystal Oscillator

Suggested Reflow Profile

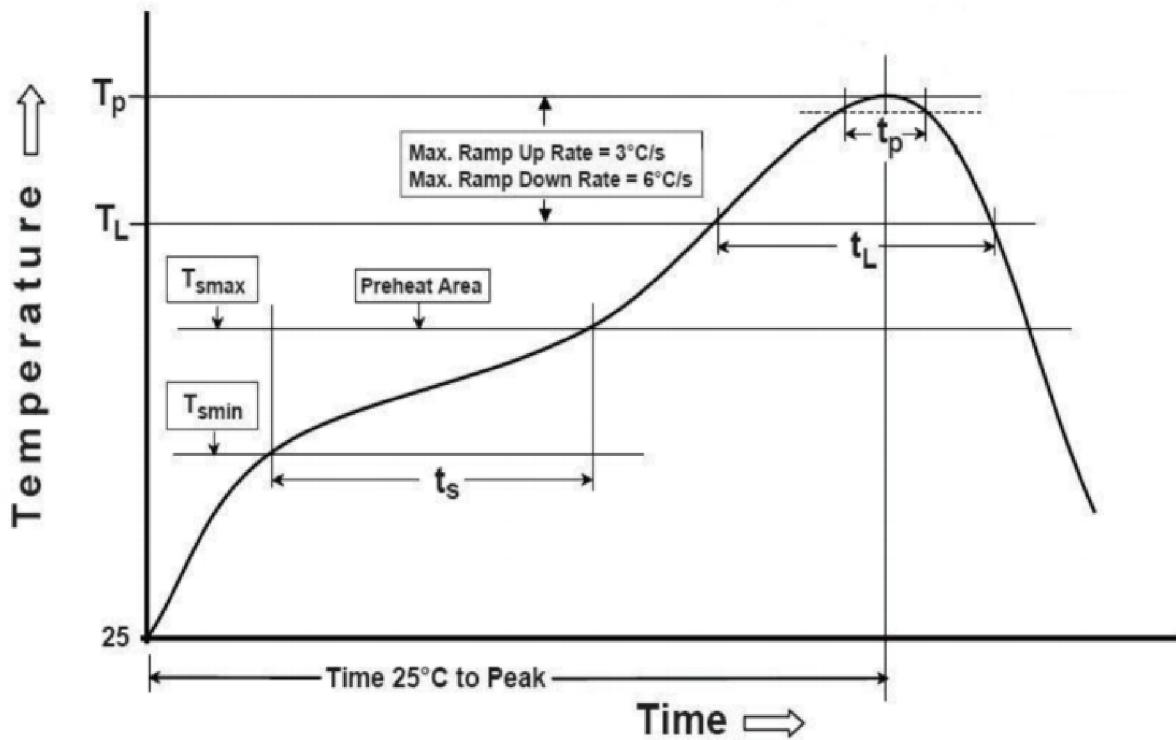

Profile Feature	Sn - Pb Eutectic Assembly	Preheat / Soak
Preheat / Soak <ul style="list-style-type: none"> ● Temperature Min (Ts min) ● Temperature Max (Ts max) ● Time (Ts min to Ts max) 	100°C 150°C 60-120 seconds	150°C 200°C 60-120 seconds
Ramp - up rate (TL to Tp)	3°C/ second max.	3°C/ second max.
Time maintained above <ul style="list-style-type: none"> ● Liquidous temperature (TL) ● Time (tL) maintained above TL 	183°C 60-150 seconds	217°C 60-150 seconds
Peak package body temperature (Tp)	235°C	260°C
Time within 5° C of the specified classification temperature (Tp)	20 seconds	30 seconds
Ramp - down rate (Tp to TL)	6°C/ second max.	6°C/ second max.
Time 25° C to peak temperature	6 minutes max.	8 minutes max.
Suggest reflow times	2 Times max.	

更新日期：2024年4月10日

A3C Series 3.2 x 2.5 mm SMD Automotive Crystal Oscillator

A : Automotive

3 : 3.2×2.5×0.95 mm | SMD3225-4P

C : Crystal Oscillator

Testing Circuit

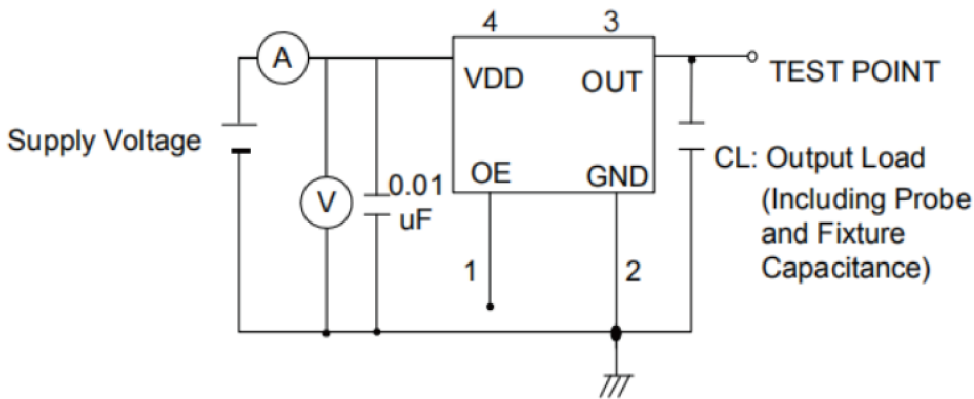

※ Notes: PIN 1 connected to Vdd or floating, the product is working properly; connected to GND, stops working.

Waveform Conditions

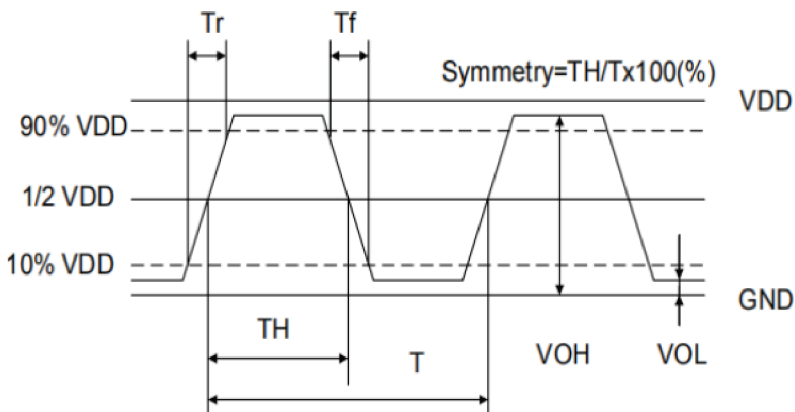

Waveform measurement system should have a min. bandwidth of 5 times the frequency being tested.

A3C Series 3.2 x 2.5 mm SMD Automotive Crystal Oscillator

A : Automotive

3 : 3.2×2.5×0.95 mm | SMD3225-4P

C : Crystal Oscillator

Packaging Information

T=Tape and reel (3,000pcs/reel)

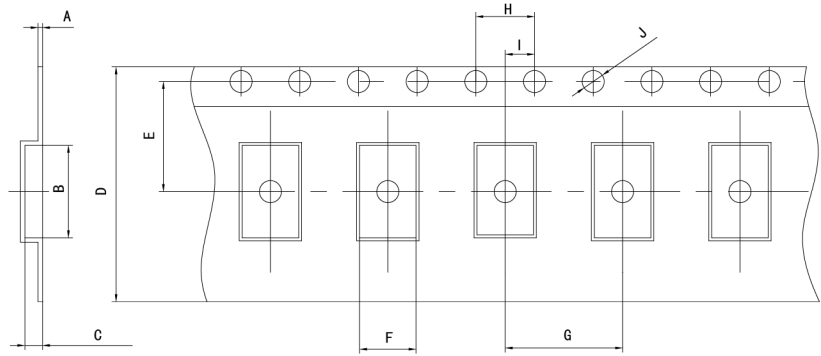
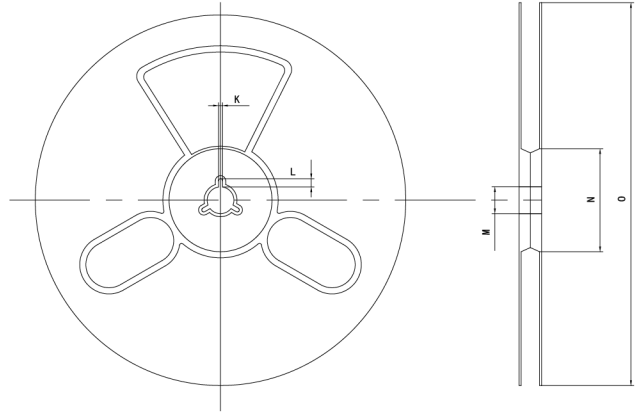

Pocket Tape Dimensions(mm)

Series	A	B	C	D	E	F	G	H	I	J	K	L	M	N	O
A3C	0.25±0.05	3.5±0.1	1.4±0.1	8.0±0.1	3.5±0.1	2.70±0.1	4.0±0.1	4.0±0.1	2.0±0.1	φ1.5±0.1	2.0±0.2	4.0±1.0	φ13±0.5	φ60±1	φ180±1